

Data Sheet

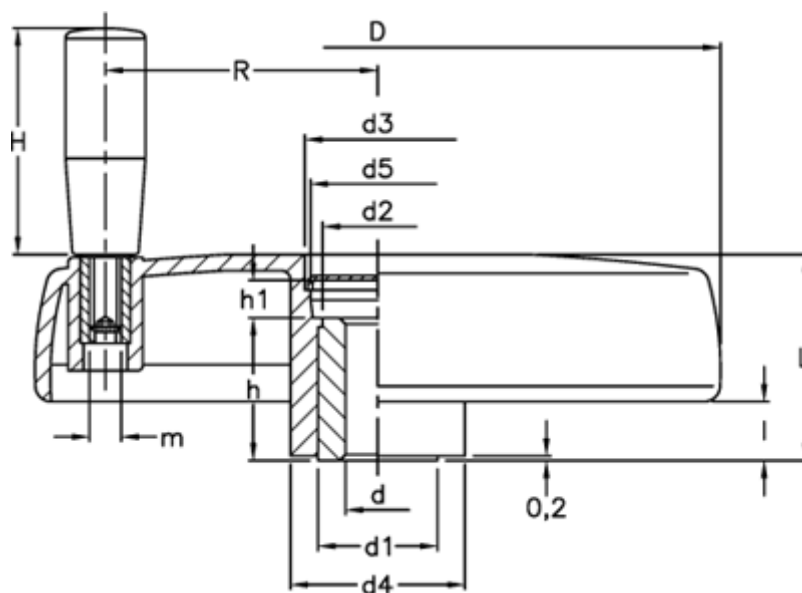

Article number: 2301072652
Description: E+G Handwheel
VDS.80+I-A10

Measures



C (N m) = 34	H = 40
D = 83	h = 17
d1 = 18	h1 = 8
d2 = 16.0	l = 9
d3 = 21.0	L = 29
d4 = 26	L (J) = 6
d5 = 19	m = M6
d H7 = 10	R = 30.5